



CATENACCIO E SCROCCO - DEAD AND LATCH BOLT



CARATTERISTICHE COSTRUTTIVE: Scatola e coperchio in acciaio zincato e plastificato - Frontale in acciaio inox - Catenaccio in lega speciale nichelata - Scrocco anti-rumore in lega speciale nichelata - Ingegno maniglia in lega speciale zincata foro \varnothing 8 mm - Cilindro a spillo cod. 4054 o 4054/1 (con chiavi lunghe).

FUNZIONAMENTO: Catenaccio comandato dalla chiave - Scrocco comandato dalla maniglia.

MANO: Reversibile.

PARTI IN DOTAZIONE: 3 chiavi, 2 borchie cod.0441 N.





CONSTRUCTIVE FEATURES: Zinc and plastic plated steel case and cover - Stainless steel forend - Nickel-plated special alloy dead bolt - Nickel-plated special alloy anti-noise latch bolt - Zinc-plated special alloy square spindle device \varnothing 8 mm - Cross cylinder cod.4054 or 4054/1 (with long keys).

WORKING: Key driven dead bolt - Handle driven latch bolt.

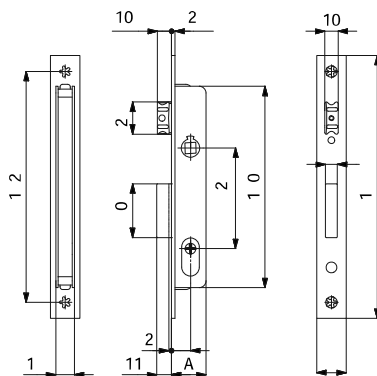
HAND: Reversible.

PROVIDED WITH: 3 keys, 2 escutcheons cod.0441 N.



COD.	E	F	A		mandate throws	 kg		
4350	15	16	26	4100	1	0,37	1	10
4350/F22	15	22	26	4100	1	0,39	1	10
4330	20	16	31	4100	1	0,39	1	10
4330/F22	20	22	31	4100	1	0,41	1	10
43**/1	Chiavi lunghe Long keys			4101	-	+ 0,02	-	-

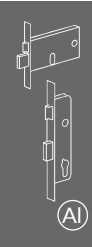

CATENACCIO E SCROCCO REGOLABILE - DEAD AND ADJUSTABLE LATCH BOLT

SCROCCO INTERCAMBIABILE CON RULLO COD. 0535 - LATCH BOLT INTERCHANGEABLE WITH ROLLER BOLT COD. 0535



CARATTERISTICHE COSTRUTTIVE: Scatola e coperchio in acciaio zincato e plastificato - Frontale in acciaio inox - Catenaccio in lega speciale nichelata - Scrocco anti-rumore in lega speciale nichelata - Ingegno maniglia in lega speciale zincata foro \varnothing 8 mm - Cilindro a spillo cod. 4054 o 4054/1 (con chiavi lunghe).

FUNZIONAMENTO: Catenaccio comandato dalla chiave - Scrocco comandato dalla chiave o dalla maniglia.

MANO: Reversibile.

PARTI IN DOTAZIONE: 3 chiavi, 2 borchie cod. 0441 N.





CONSTRUCTIVE FEATURES: Zinc and plastic plated steel case and cover - Stainless steel forend - Nickel-plated special alloy dead bolt - Nickel-plated special alloy anti-noise latch bolt - Zinc-plated special alloy square spindle device \varnothing 8 mm - Cross cylinder cod. 4054 or 4054/1 (with long keys).

WORKING: Key driven dead bolt - Handle or key driven latch bolt.

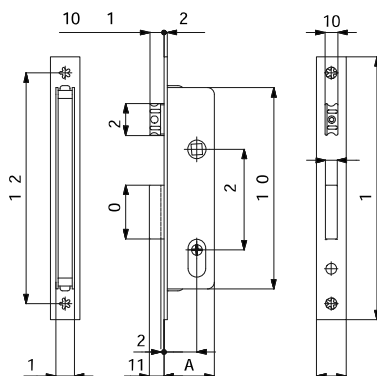
HAND: Reversible.

PROVIDED WITH: 3 keys, 2 escutcheons cod. 0441 N



COD.	E	F	A		mandate throws	 kg		
4338	25	16	38	4100	1	0,44	1	10
4338/F22	25	22	38	4100	1	0,46	1	10
4530	30	16	43	4100	1	0,47	1	10
4530/F22	30	22	43	4100	1	0,49	1	10
4***/1	Chiavi lunghe Long keys			4101	-	+ 0,02	-	-